

Data Sheet



Article number: 204260M1675A0UK

Description: E+G levelling foot
GN 42-60-M16-75-A0-UK

Note: UK With nut, Hexagon socket at the top, Wrench flat at the bottom

Measures

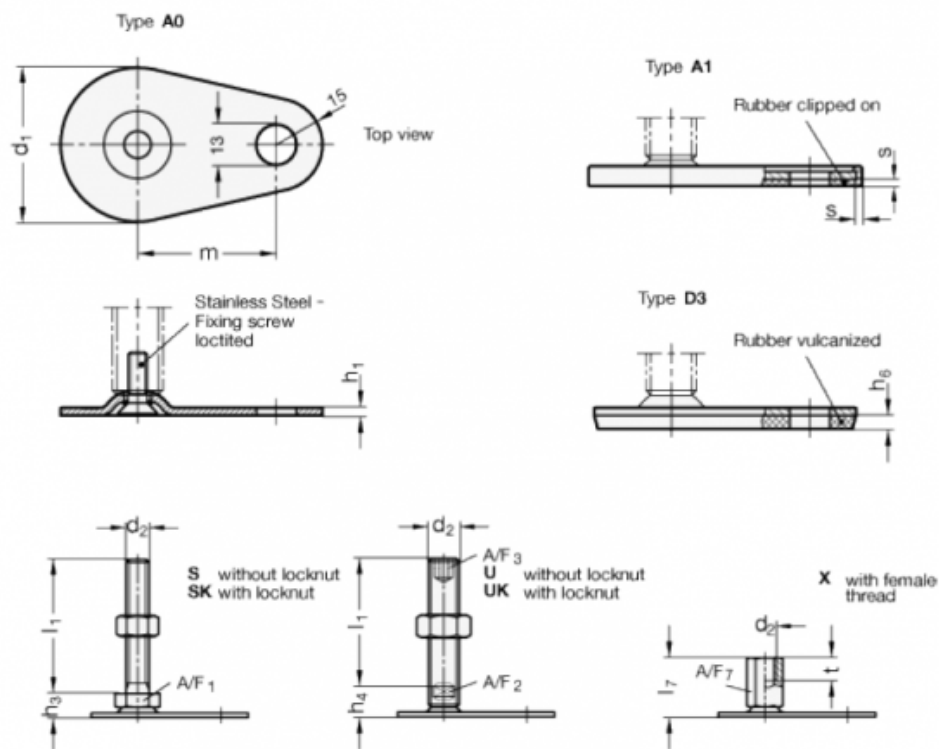

A/F2 = 12	m = 50
A/F3 = 8	s =
d1 = 60	
d2 = M16	
h1 = 2.5	
h4 = 17	
h6 =	
l1 = 75	